

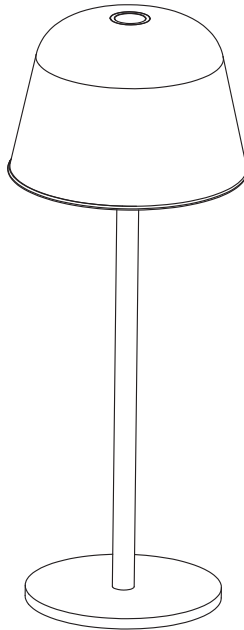

---







**ENDURA® STYLE STAN TABLE**

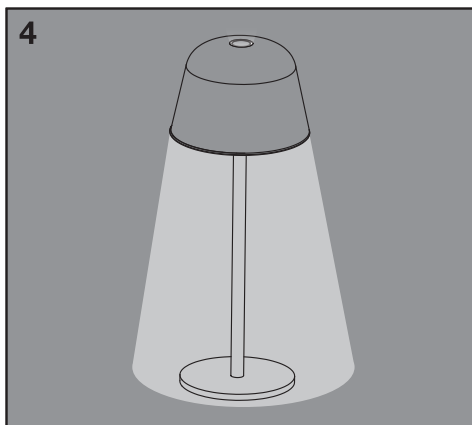
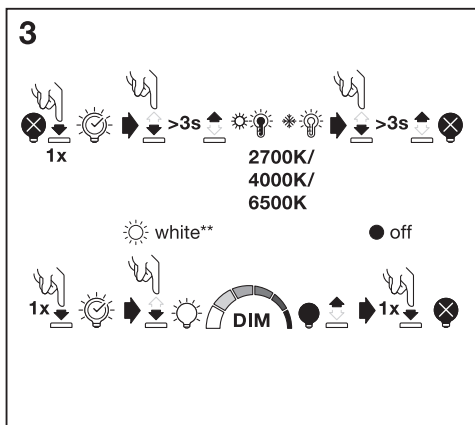
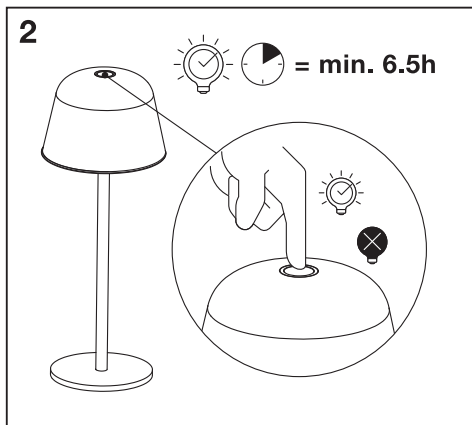
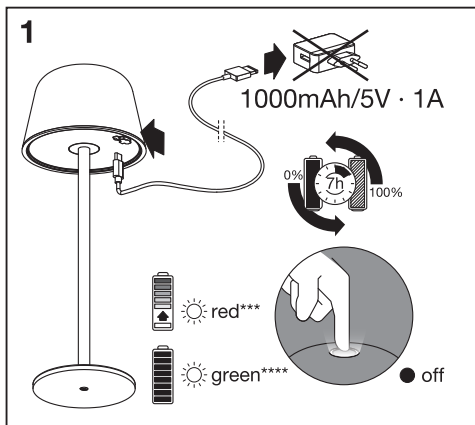
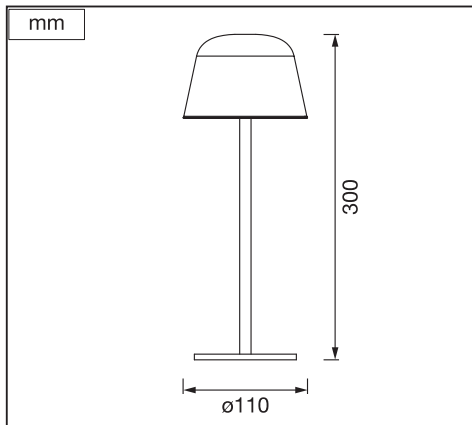
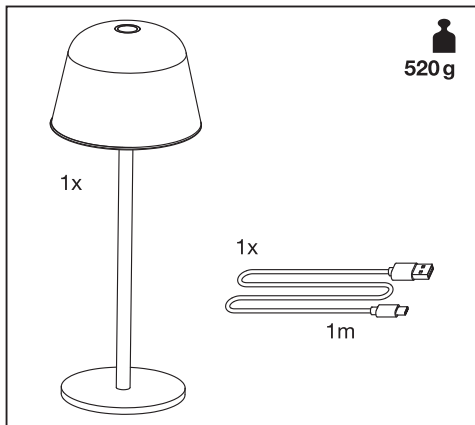



























---































	EAN	W	Im Light Source	Im Output	K	° (°C)	V <sub>bc</sub>	▽ (°)	
ENDURA STYLE STAN TABLE CCT USB BG	4099854185342	2.5	280	200	2700/4000/6500	-20...+40	5	100	100000
ENDURA STYLE STAN TABLE CCT USB DG	4099854185366	2.5	280	200	2700/4000/6500	-20...+40	5	100	100000
ENDURA STYLE STAN TABLE CCT USB MG	4099854185380	2.5	280	200	2700/4000/6500	-20...+40	5	100	100000



					
	EAN	n		OR code	* X =
ENDURA STYLE STAN TABLE CCT USB BG	4099854185342	1	AC55555		E
ENDURA STYLE STAN TABLE CCT USB DG	4099854185366	1	AC55555		E
ENDURA STYLE STAN TABLE CCT USB MG	4099854185380	1	AC55555		E

\*  Dieses Produkt enthält eine Lichtquelle der Energieeffizienzklasse <X>.  This product contains a light source of energy efficiency class <X>.  Ce produit contient une source lumineuse de classe d'efficacité énergétique <X>.  Questo prodotto contiene una sorgente luminosa di classe di efficienza energetica <X>.  Este producto contiene una fuente luminosa de la clase de eficiencia energética <X>.  Este produto contém uma fonte de luz da classe de eficiência energética <X>.  Το προϊόν αυτό περιέχει φωτεινή πηγή της τάξης ενεργειακής απόδοσης <X>.  Dit product bevat een lichtbron van energie-efficiëntieklasse <X>.  Denna produkt innehåller en ljuskälla med energieffektivitetsklass <X>.  Tämä tuote sisältää valonlähteen, jonka energiatehokkuusluokka on <X>.  Dette produktet indeholder en lyskilde med energieffektivitetsklasse <X>.  Dette produkt indeholder en lyskilde i energieffektivitetsklasse <X>.  Tento výrobek obsahuje světelný zdroj s třídou energetické účinnosti <X>.  Данный продукт содержит энергосберегающий источник света (класса <X>).  Ez a termék egy <X> energiatékonysági osztályú fényforrást tartalmaz.  Ten produkt zawiera źródło światła o klasie efektywności energetycznej <X>.  Tento výrobok obsahuje svetelný zdroj triedy energetickej účinnosti <X>.  Ta izdelek vsebuje svetlobni vir razreda enerjske učinkovitosti <X>.  Bu ürün, enerji verimliliği sınıfında bir ışık kaynağı içerir <X>.  Ovaj proizvod sadrži izvor svetlosti klase energetske učinkovitosti <X>.  Acest produs conține o sursă de lumină cu clasa de eficiență energetică <X>.  Tooni produkt vključva svetlinen iztočnik s klas na energijina efektivnost <X>.  Toode sisaldab energiatõhususe klassi <X> valgusallikat.  Šiame gaminyje yra šviesos šaltinis, kurio energijos vartojimo efektyvumo klasė <X>.  Ši s ražojums satur gaismas avotu, kura energoefektivitātes klase ir <X>.  Ovak proizvod sadrži izvor svetlosti klase energetske efikasnosti <X>.  Цей виріб містить джерело світла класу енергоефективності <X>.  Бул өнімде <X> энергия тиімділігі класының жарық көзі бар.

\*\*  weiß  white  blanc  bianco  blanco  branco  λευκό  wit  vit  valkoinen  hvit  hvid  bílá  белый  fehér  biały  biela  beia  beyaz  bijela  alb  бял  valge  balta  balts  bela  бeлa  бeлaй  ақ

\*\*\*  rot  red  rouge  rosso  rojo  vermelho  κόκκινο  rood  rōd  punainen  rød  rød  červená  красный  piros  czerwony  červená  rdeča  kırmızı  crvena  roșu  Червено  punane  raudonas  sarkans  crvena  червоний  қызыл

\*\*\*\*  grün  green  vert  verde  verde  verde  πράσινο  groen  grön  vihreä  groen  grön  zelená  зелёный  zöld  zielony  zelená  yeşil  zelena  verde  Зелено  roheline  žalias  žals  zelena  зелений  жасыл

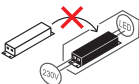
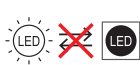

IP54 



**FR**  
 Cet appareil,  
 ses accessoires  
 et son cordon,  
 se recyclent

À DÉPOSER  
 EN MAGASIN

À DÉPOSER  
 EN DÉCHÈTERIE

 OU 

Points de collecte sur [www.quefairedemesdechets.fr](http://www.quefairedemesdechets.fr)

C10449057  
G11172996  
15.08.2023



LEDVANCE GmbH  
Steinerne Furt 62  
86167 Augsburg, Germany  
[www.ledvance.com](http://www.ledvance.com)